



GE&EL+ vAC/DC ePlus SiC



Model 50 kW

The GE+EL vAC/DC SiC is our whole catalog in a single cabinet, with all the features that define our products: robustness, efficiency, and quality, with cutting-edge technology to enhance the product to higher performance. This All-Terrain converter with SiC Technology is suitable for the majority of test applications in the field of Renewable Energies, Smartgrids, Power HiL, Batteries and Electrical Vehicles.



Regenerative Technology

Thanks to our bi-directional topology, the All-Terrain AC/DC SiC Converter are regenerative, resulting in a reduction of both the consumed energy during the tests and the power required from the electrical installation.

This technology allows us to work in both directions, as power generators or offering a consumption for the realization of all types of tests.

Main Applications



Electromobility



Smart Grids

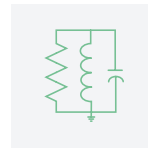

Anti-Islanding



IEC Testing

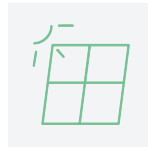

Photovoltaic

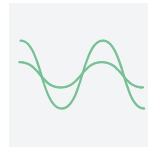

Academical & Industrial Test



Power HiL



Energy Storage System

What's new

HIGHER SWITCHING FREQUENCY

Thanks to the SiC MOSFETs in our equipment, the switch is increased up to 60 kHz.

BANDWIDTH

A higher bandwidth of the converter translates into a better capacity to control fast-changing and high-frequency signals.

RIPPLE

The increase of the switching frequency is high enough to significantly improve the current ripple (3 times) and voltage ripple (2.75 times) due to the switching.

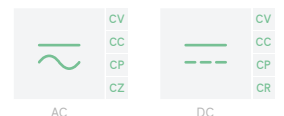

EFFICIENCY

Thanks to the use of SiC MOSFETs at both converters of the back-to-back configuration, the peak efficiency of the whole system is boosted above 94%.

CURRENT IN DC MODE

Our equipment has the same current capacity in DC as in AC mode.

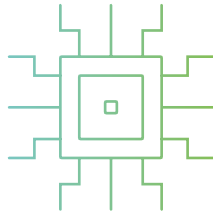

Hardware

The creation of this product is based on the replacement of the IGBTs by SiC MOSFETs.

Their characteristics allow us to make optimize the design and control of current equipment:

One of the main differences at the control level is the increase of the switching frequency.

Benefits of higher switching frequency

In switched power converters, as the converters from Cinergia, the power semiconductors work in two states: completely OFF (zero current) or entirely ON (near zero voltage). While transitioning from one state to the other, the voltages and currents do not change immediately and therefore are both non-zero during some short time. This current-voltage crossover generates power losses in the semiconductor at each switching cycle, which happens at 15 kHz.

The main benefit of SiC MOSFETs is the faster switching time, thus reducing the current-voltage crossover duration, and therefore reducing the losses at each commutation.

As the losses at each commutation are reduced, the switching frequency of the SiC MOSFET can be increased without increasing the total losses or even reducing the switching losses compared to the standard IGBT.

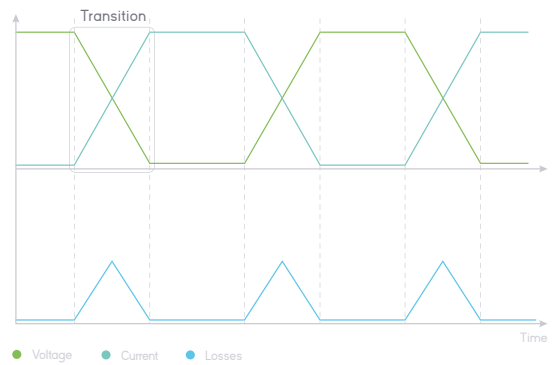

The output filtering stage can be reduced when the converter's switching frequency increases, and the output filtering stage can be reduced. That is, it needs less attenuation for the same output ripple. This implies that the cutoff frequency of the filter increases, and therefore also the resonance frequency of this filter. These effects increase the bandwidth of the control and, thus, the bandwidth of the whole converter.

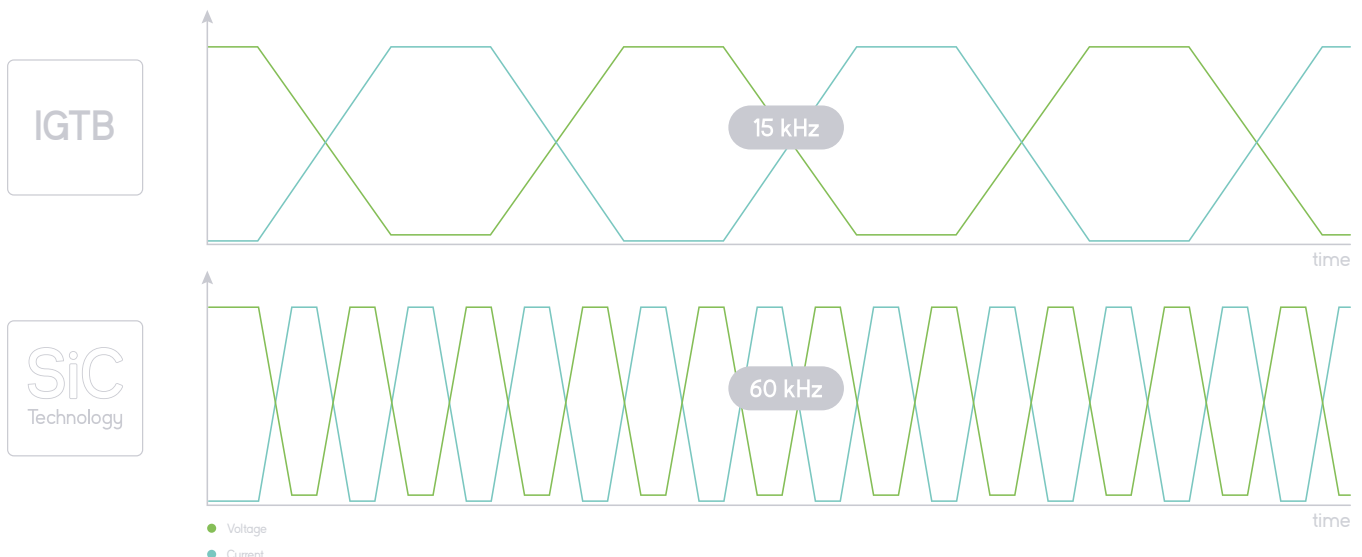

Bandwidth

A higher bandwidth of the converter translates into a better capacity to control fast-changing and high-frequency signals, which provides the following direct benefits for the user:

- A higher slew rate of output currents and voltages is especially noticeable when the equipment is used in power amplifier mode.
- But this is also very useful in any other mode to maintain the given set point while supporting fast transients and disturbances from the equipment connected to the output.
- Capacity to generate fundamental frequencies from 10 Hz to 1000 Hz.
- The voltage-frequency limit of the equipment is increased from 46000 V·Hz to 230000 V·Hz, which allows fundamentals of higher amplitude and frequency (230V @ 1000 Hz) and more harmonic content.
- Better control of harmonics up to 5000 Hz.

Acoustic noise

Standard Equipment of the same power that uses IGBTs has a switching frequency of 15 kHz, which falls in the higher range of the human audible range (20 Hz - 20 kHz), but it is still audible. This frequency normally represents a compromise between the audible noise and the switching losses of traditional IGBTs. Thanks to the SiC MOSFETs in our equipment, the switching noise is increased up to 60 kHz, making the switching completely inaudible.



Ripple

Despite the reduction of the output filter, the increase of the switching frequency is high enough to significantly improve the current ripple (3 times) and voltage ripple (2.75 times) due to the switching. This is thanks to an equilibrated selection of hardware elements and control adjustment.

Efficiency

The SiC MOSFETs are much more efficient than the IGBTs, not only regarding the switching losses but also regarding the conduction losses. Additionally, because the power filter is reduced, the losses of this filter are also reduced. Lastly, the MOSFET also incorporates a more efficient antiparallel SiC diode that also reduces the losses. All the effects translate into an increase in efficiency, despite that the switching frequency has been increased four times.

Thanks to the use of SiC MOSFETs at both converters of the back-to-back configuration, the peak efficiency of the whole system is boosted above 94%.

Current in DC Mode

The SiC MOSFETs used in the converter also include a SiC diode in antiparallel, which has better electrical characteristics than a standard silicon diode, specifically switching and conduction losses. On one side, this helps reduce global losses, but on the other, it allows higher re-circulation currents, which is a limiting factor when working in DC at nominal current and low voltages. Thanks to this SiC diode, our equipment now has the same current capacity in DC as in AC mode.



Bidirectional and Regenerative Hardware

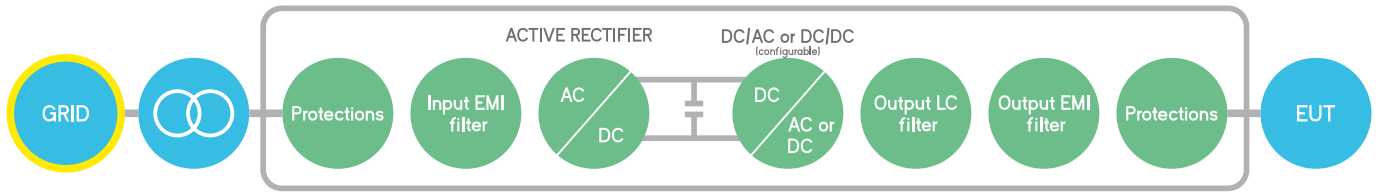

The hardware platform is based on a Back-to-Back power conversion topology, formed by two IGBT-based power stages. The grid side stage is an Active Rectifier which produces clean sinusoidal currents with very low harmonic distortion and power factor close to one.

The EUT side stage can be configured for AC voltage source or AC current source or DC output. In AC, voltage/current are controlled by using state of the art digital Proportional-Resonant controllers. In DC, the three independent buck-boost bidirectional legs enable the separated control of three different DC voltages or currents.

Block Diagram

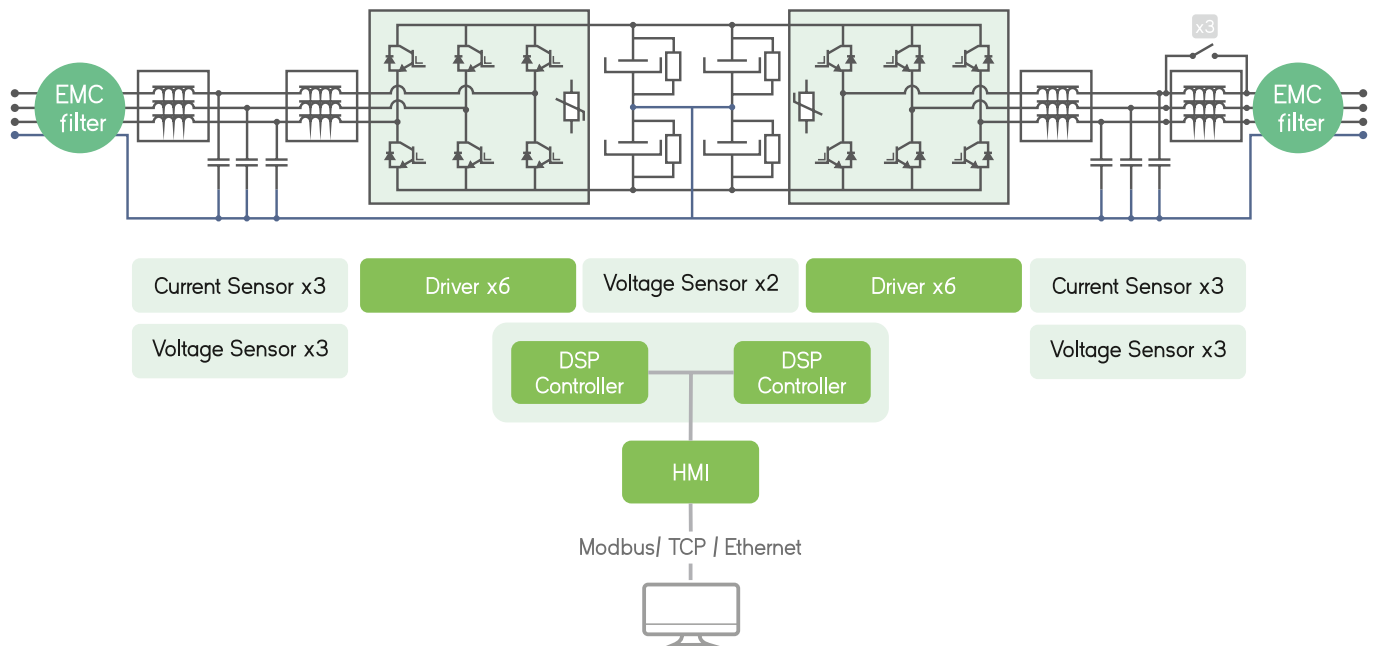

Better than ever, the enhanced **Plus** family

MASTER/SLAVE CONNECTION

by using a fiber optics link to increase power/voltage capabilities:

GE in AC: can be connected in parallel

EL in AC: can be connected in parallel

B2C: can be connected in parallel, or series or both

FASTER

30kHz control loop frequency

MORE HARMONICS

50 per phase with 20 free-harmonics

DELTA LOAD

for the EL in AC mode

ADJUSTABLE DC TRANSIENT

controllers to improve stability of the system

OPTIMIZED RMS CALCULATION

for PV inverters anti-islanding test

SAME ELECTRICAL RATINGS and SAME BANDWIDTH

because the power platform does not change so robustness and ratings remain the same.



ePLUS keeps the robustness, ratings and all the functionalities of the PLUS platform and adds the new features described in this datasheet

Software



The user interface used by CINERGIA devices has been developed by our R&D team, to offer total control of the device, with a comfortable and intuitive design. This allows us to take full advantage of the capabilities of the device, as well as the programming and execution of standardized or self-created tests.

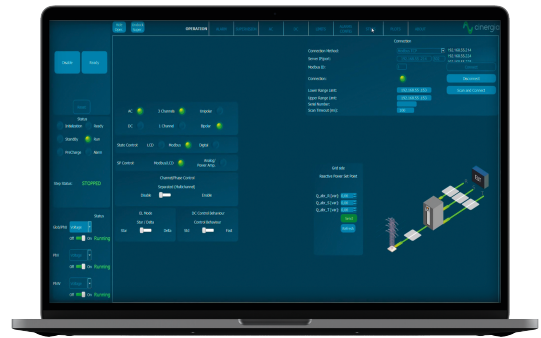

GE and EL Modes



AC Operation

From this panel, the user can set all AC parameters. Each phase can be independently configured: RMS current magnitude, phase delay, harmonics content, free-frequency harmonic and transition ramps. A plot shows the expected real-time waveform, the FFT representation and the numeric data: RMS, peak, CF and THD.



Harmonics

The device can control simultaneously the magnitude of the first 15 harmonics and one free harmonic per phase. The free one allows the generation of sub-harmonics, inter-harmonics and high frequency harmonics up to the 50th, setting both the magnitude and phase delay.

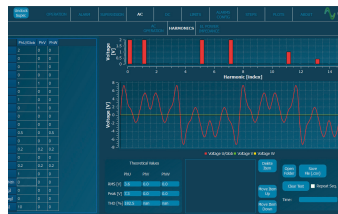

Power and Impedance Control

In Power mode, the active and reactive power of each phase is independently controlled. In Impedance mode, the device emulates an RLC load allowing to parameterize resistance, inductance and capacitance per phase making this device suitable for Anti-Islanding test of grid converters.

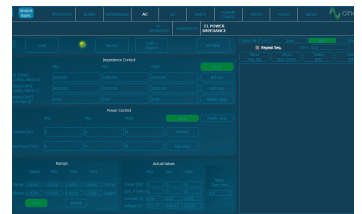

AC



Steps Mode

One of the most remarkable novelties of the new software is the steps functionality. Step test files are saved and executed by the DSP allowing deterministic timing with a resolution of 66µs. The user gains access to all registers of the device to create complex test sequences which run directly in the converter without the need of an external computer.



Disturbance Generation

The steps mode includes predefined easy-to-use test panels. The AC faults panel is a powerful yet intuitive editor which allows generating and configuring flicker. Specific profiles can be saved in .csv files, modified, and reused by importing an existing one.



IEC Testing

Optional

The last version of software includes a library supporting IEC standard for pre-compliance tests. The profiles defined in the standards are preloaded in the software for a user friendly execution and edition. Currently the following standards are available:

- IEC61000-4/11
- IEC61000-4/13
- IEC61000-4/14
- IEC61000-4/28

*It is mainly intended for pre-compliance testing. Contact us for further information.



DC

DC Operation

This panel allows the user to access all DC setpoints and limits. Thanks to the unique Multichannel feature, each phase can have a different Operation Mode: voltage, current, power, resistance and advanced DC applications. Transition ramps, voltage and current limits can be modified. The limits for sink and source operation are different for safer testing, specially in battery applications.

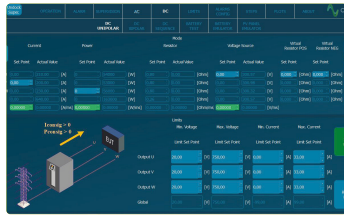

Sequence

The User Interface Software integrates a Sequence Editor to create automatic test sequences, save them for future use and import them in .csv files. A smart datalogger can be activated from the LCD of the unit to record automatically the resulting voltage and current measurements with a time resolution of 400 ms.

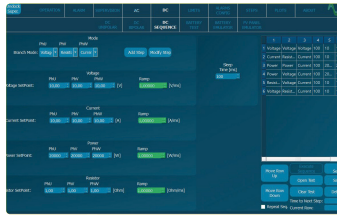

Multichannel

Enabling the Separated Channel Control converts the device in three functionally independent DC Bidirectional Power Supplies, sharing the common negative rail. Each channel can have a different status (ON, OFF, Warning, Alarm), Operation Mode (see Range and Specifications table), Setpoint, Ramp and Limits.

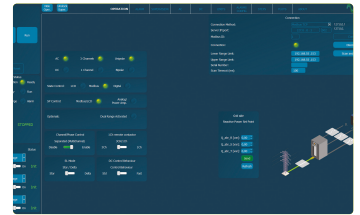

Battery Pack Tester

This functionality enables the user to precisely control the charge, discharge and cycling of a Battery. Basic parameters include the charge/discharge current, fast charge and floating voltages while Advanced parameters add Energy (Ah) and Time as transition conditions. Profiles for each Battery technology can be saved and imported in .CSV files.



Battery Emulation

The B2C+ integrates a mathematical model to emulate the voltage behaviour of a real battery pack. The output voltage will change as a function of the SOC and Current. By configuring the provided parameters, the voltage profile can be adjusted to match different technologies: Lilon, NiMH, NiCd, Pb, Flux, etc.

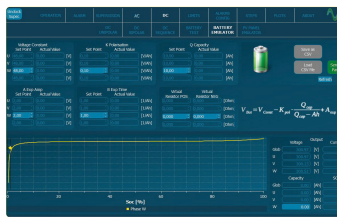

PV Panel Emulation

The PV Panel model is based on the single-diode equivalent circuit of a PV cell and the series-parallel connection of cells to form a panel. A Runtime functionality allows the simulation of a complete day by launching different irradiance and temperature setpoints from a .csv file, enabling the user burn-in and functional tests of PV Inverters.



GE&EL+ vAC/DC SiC Range & Specifications

Input side (GRID side)

AC Voltage

Rated: $3 \times 400V_{rms}$ +Neutral+ Earth
Range: +15% / -20% (-10% @ P_{rated})

Rated AC Current

Depends on model (see Wiring Manual)

Frequency

48-62Hz

Current Harmonic Distortion

THDi < 3% at rated power

Current Power Factor

PF > 0.98 at rated power

Efficiency

≥ 94%

Output side in DC (EUT side)

Terminals

Number: 6 (3 positive + 3 negative)

Configuration of Channels

Unipolar 3-channels 2Q, independent setpoints per channel

Unipolar 1-channel 2Q, one global setpoint for all channels

Multichannel: 2Q, independent start/stop, operation mode and setpoints per channel (note: multichannel is an option for ≥ 80kVA)

Bipolar (4Q two independent setpoints)

Voltage (CV)

Range: 2Q: 20⁽¹⁾ to 800V

4Q: 0 to +350V / 0 to -350 (+ rail / 0 / - rail, Bipolar configuration)

Setpoint Resolution: 10mV

Effective Resolution⁽²⁾: < 0.05% of FS⁽³⁾

Setpoint Accuracy⁽⁴⁾: ± 0.1% of FS⁽³⁾

Transient Time⁽⁵⁾: < 250µs (10% to 90% at a step to V_{rated})⁽¹⁰⁾

Slew Rate: Configurable, Max 4V/µs

Ripple⁽⁷⁾ (peak-peak): < 0.35% of FS⁽³⁾ (2.5 V peak-peak)

Current Mode (CC)

Range: from 0 to ± 110% of I_{rated} (see models table)

Setpoint Resolution: 10mA

Effective Resolution⁽²⁾: < 0.05% of FS⁽³⁾

Setpoint Accuracy⁽⁴⁾: ± 0.2% of FS⁽³⁾

Transient Time⁽⁵⁾: < 100µs (10% to 90% at a step to I_{rated})⁽¹⁰⁾

Slew Rate: 1 A/µs

Ripple⁽⁷⁾ (peak-peak): < 0.35% of FS⁽³⁾ (1A peak-peak)

Power Mode (CP)

Range: from 0 to ± 130%⁽⁸⁾ of P_{rated} (see models table)

Derived current setpoint: $P_{setpoint} / V_{measured}$

Setpoint Resolution: 1W

Effective Resolution⁽²⁾: < 0.1% of FS⁽³⁾

Setpoint Accuracy⁽⁴⁾: ± 0.4% of FS⁽³⁾

Transient Time⁽⁵⁾: < 100µs (10% to 90% at a step to P_{rated})⁽¹⁰⁾

Slew Rate: 1 A/µs

Resistance Mode (CR)

Range: from 0.1 to 1000 Ohm

Derived current: $V_{measured} / R_{setpoint}$

Setpoint Resolution: 0.01 Ohm

Setpoint Accuracy⁽⁴⁾: ± 0.2% of FS⁽³⁾

Transient Time⁽⁵⁾: < 100µs (10% to 90% at a step to R_{rated})⁽¹⁰⁾

Slew Rate: 1 A/µs

Output side in AC (EUT side)

Terminals

Number: 4 (3 phases + 1 neutral)

Configuration of Channels

3 channels: 4Q, independent setpoints per phase

1 channel: 4Q, global setpoints for all phases (only in GE+)

Multichannel: 4Q, independent start/stop, alarm status and setpoints per phase (note: multichannel is an option for $\geq 80\text{kVA}$)

Output side in GE-AC

Voltage Mode (CV)

Peak: $\pm 420\text{V}$ phase-neutral

Range: $0^{(1)}$ to 295Vrms phase-neutral
 $0^{(1)}$ to 510Vrms phase-phase

**THDv: $< 0.08\%$ rated linear load at 230Vrms , $50/60\text{Hz}$
 $< 0.8\%$ rated non linear load $\text{CF}=3$ at 230Vrms , $50/60\text{Hz}$**

Setpoint Resolution: 10mVrms

Effective Resolution⁽²⁾: $< 0.05\%$ of $\text{FS}^{(3)}$

Setpoint Accuracy⁽⁴⁾: $< \pm 0.1\%$ of $\text{FS}^{(3)}$

Transient Time⁽⁵⁾: $< 100\mu\text{s}$ (10% to 90% at a transient 0 to $420\text{V}_{\text{peak}}$)

Slew Rate: Configurable, Max $4\text{V}/\mu\text{s}$

Ripple⁽⁷⁾ (peak-peak):

$< 0.15\%$ of $\text{FS}^{(3)}$ ($\leq 1.2\text{V}$ peak-peak with a Bandwidth $< 500\text{kHz}$)

$< 0.12\%$ of $\text{FS}^{(3)}$ ($< 1\text{V}$ peak-peak with a Bandwidth $< 250\text{kHz}$)

Enhanced

Harmonics

Range: up to 5kHz (up to 50th harmonic)

50 independent harmonics per phase:

21 free programmable frequency and phase from 0.1 to 50 times f_0

29 fixed frequency

Harmonics content: $V \cdot f < 230000$ (with current derating)

Frequency

Fundamental Frequency Range: 10 to 1000Hz

Small Signal Bandwidth: up to $5000\text{Hz}^{(9)}$

Resolution: 1mHz

Phase Angle

Range: 0 to 360°

Resolution: 0.01°

Output side in EL-AC

Admissible Voltage

Connection: 1-phase, 3-phase star or 3-phase delta

Maximum: $\pm 400\text{V}$ peak (420V with HV option)

Range: 10- 1000Hz

35 to 277Vrms phase-neutral (295Vrms with HV option)

35 to 480Vrms phase-phase (510Vrms with HV option)

Maximum rms voltage follows $V \cdot f < 230000$

Current Mode (CC)

Range: from 0 to $\pm 130\%$ ⁽⁸⁾ of I_{rated} (see models table)

Setpoint Resolution: 10mA_{rms}

Effective Resolution⁽²⁾: $< 0.05\%$ of $\text{FS}^{(3)}$

Setpoint Accuracy⁽⁴⁾: $< \pm 0.2\%$ of $\text{FS}^{(3)}$

Transient Time⁽⁵⁾: Model 50 [$< 100\mu\text{s}$ (10% at 90%)]

Slew Rate: $1\text{A}/\mu\text{s}$

Ripple⁽⁷⁾ (peak-peak): $< 0.35\%$ of $\text{FS}^{(3)}$

Phase Angle ($\cos \phi$)

Range: -90 to 90° in Sink / Source

Resolution: 0.01°

Enhanced

Harmonics

Range: up to 5kHz (up to 50th harmonic)

50 independent harmonics per phase:

21 free programmable frequency and phase from 0.1 to 50 times f_0

29 fixed frequency

Power Mode (CP / CS)

Range: from 0 to $\pm 130\%$ ⁽⁶⁾ of Prated (see models table)

The current setpoint is derived from ISI and <S

Setpoint Resolution: 1W, 1VA

Effective Resolution⁽²⁾: < 0.1% of FS⁽³⁾ (< 0.25% models 7.5 & 10)

Setpoint Accuracy⁽⁴⁾: $\pm 0.4\%$ of FS⁽³⁾

Transient Time⁽⁵⁾: Model 50 [$< 100 \mu\text{s}$ (10% at 90%)]

Slew Rate: 1 A/ μs

Enhanced

Impedance Mode (CZ)

Calculation method configurable (rms, instantaneous)

Range: from 0.8 to 1000 Ohm, 0.1 to 2000mH, 0 to 3.7mF

Current setpoint derived from |Z| and <Z

Setpoint Resolution: 0.01 Ohm/mH/mF

Setpoint Accuracy⁽⁴⁾: see current accuracy

Transient Time⁽⁵⁾: Model 50 [$< 100 \mu\text{s}$ (10% at 90%)]

Slew Rate: 1 A/ μs

Operation Modes

DC

Programmable Voltage (CV)

Programmable Current (CC)

Programmable Power (CP)

Programmable Resistance (CR)

Steps / up to 99 comands

Optional Battery Testing (BTest) (charge/discharge/cycling)

Optional Battery Emulation (Bemu)

Optional PV Panel Emulation (PVEmu)

AC

Programmable Voltage (CV) (only in GE+)

Programmable Current (CC) (only in EL+)

Programmable Power (CP / CS) (only in EL+)

Programmable Impedance (CZ) (only in EL+)

Steps / up to 99 comands

Optional LVRT, IEC 61000 -4-11, 4-13, 4-14, 4-28

Power Amplifier (PHIL)

Delay Analogue Input - Real Power Output: 150 μs

Delay Real Power Output - Analogue Output Signal: 130 μs

* Delay time calculated working in AC configuration.

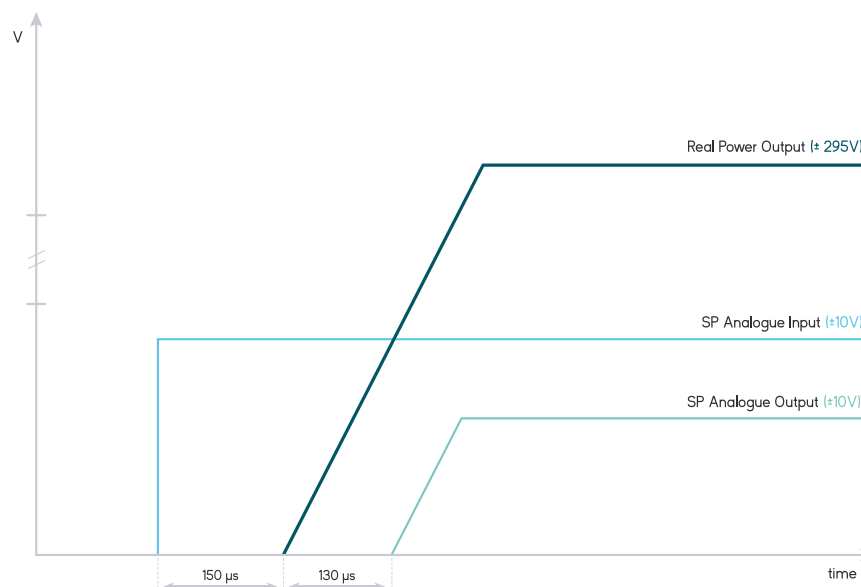

Overload/ Overcurrent

Admissible DC overcurrent is: 110% of rated value during 1 minute

Admissible AC overcurrent: 115% of rated value during 10 minutes,

120% during 1 minute, 130% during 2 seconds

Admissible overloads: 115% of rated value during 10 minutes,

120% during 1 minute, 130% during 2 seconds

User Interface

Local Control (4.3" Touchscreen panel)

Isolated Digital port: 6 inputs, 4 outputs
 Isolated Analogue port: 6 inputs (rms setpoints or power amplifier), 6 outputs (rms readback or real-time readback)
 Interlock port: 1 NC Input, 1 NO Output
 Emergency Stop pushbutton

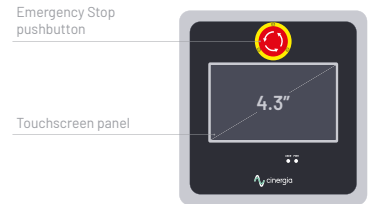

Remote Control Port

LAN Ethernet with Open Modbus-TCP protocol
 RS485 (option), CAN and RS232 (using external gateway)

Software

Graphical User Interface for Windows 7/10
 LabView drivers and open Labview interface example

Enhanced

Master/Slave Operation

Connection: fiber optics link (x6)
 Configuration: from software user interface/MODBUS up to 8 units:
 AC: Parallel
 DC: Parallel, serial or serial-parallel

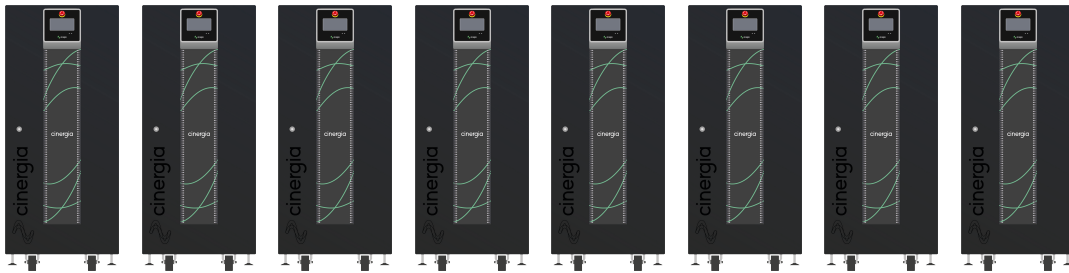

Size and Weight

Model 50 ITe

Height
1100 mm
Width
450 mm
Depth
770 mm
Weight
200 kg

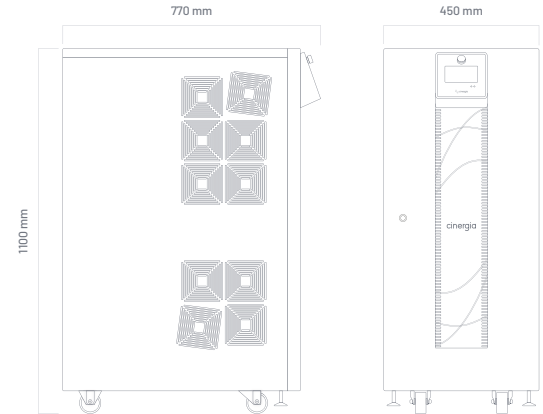

Model 50 ITi

Isolation Transformer inside the cabinet

Height
1100 mm
Width
835 mm
Depth
770 mm
Weight
395 kg

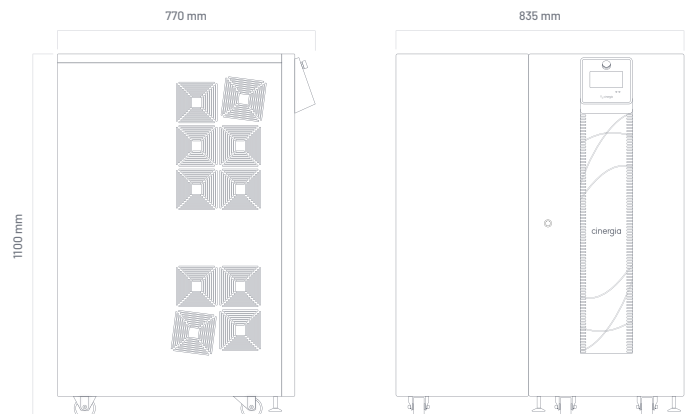

Connections

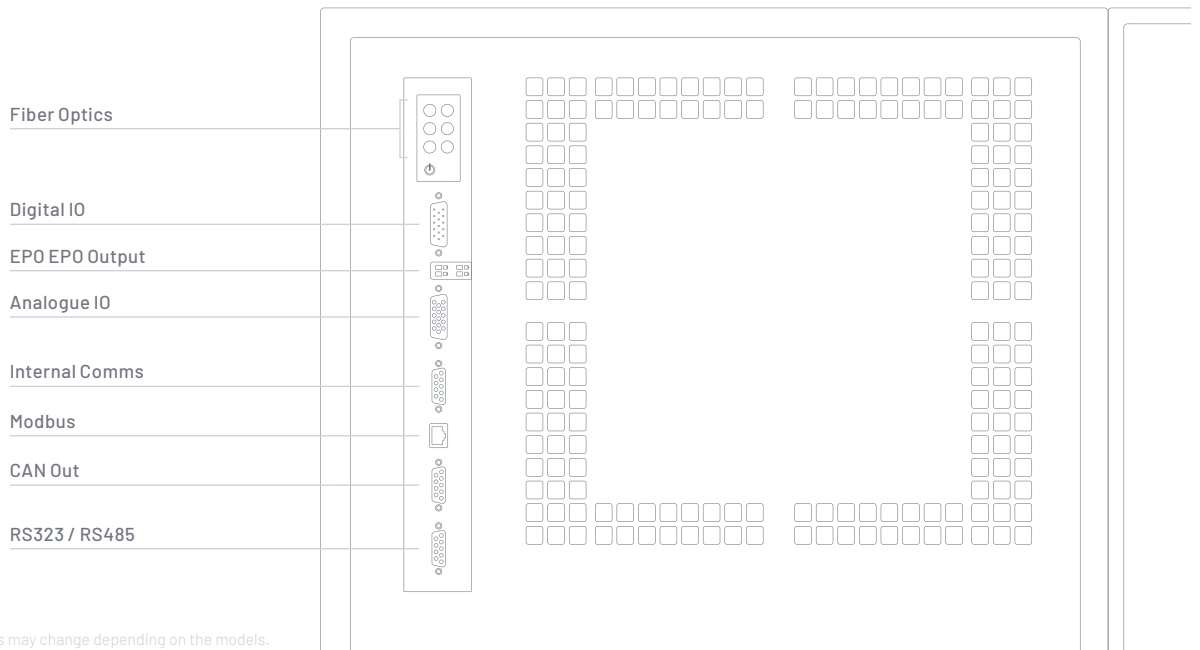

The distribution of the connectors may change depending on the models.

Selectors

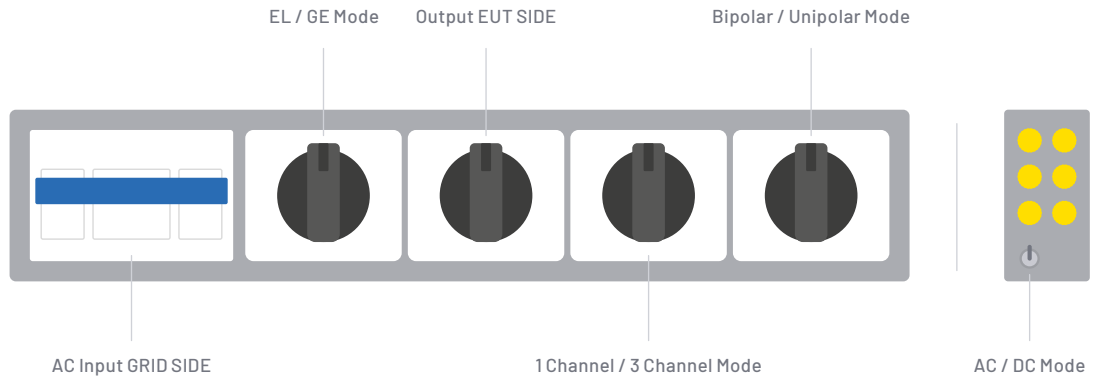

The type of selectors and their location may change depending on the models.

Protections

Overvoltage (peak, rms), Overcurrent (peak, rms), Overload
 Shortcircuit, Emergency Stop, Watchdog, Heart Beat, Output
 Contactor, Wrong Configuration
 Alarms and Limits are user configurable and can be saved in a
 password protected EEPROM

Mesurements ⁽⁶⁾

Grid Voltage (rms), Current (rms), Power (P,O) and Frequency
 Output Voltage (rms, avg), Current (rms, avg), Power (P,O) and Frequency
 Heatsink Temperatures(x2) and DC Link Voltage
 Datalogging available through FTP connection

Ambient

Operating temperature⁽⁶⁾: 5-40°C
 Relative Humidity: up to 95%, non-condensing
 Cooling: Forced air
 Acoustic noise at 1m: < 52dB(A)(7.5 to 60), < 65dB(A)(80 to 120), < 70dB(A)(160 and 200)

Standards

CE Marking
Operation and Safety: EN-50178, EN-62040-1
EMC: EN-62040-2
RoHS

All specifications are subject to change without notice.

Options

Choose your options:

- Three channel mode: allows different operation mode start/stop/reset per channel
- Isolation monitor (advised for IT systems)
- Anti-islanding monitor (only advised in net injection to the grid and following local regulations)
- RS485
- Battery Emulation
- Battery Test
- PV Panel Emulation
- Predefined Tests: LVRT, IEC 61000-4-11, 4-13, 4-14, 4-28 (consult us for specific Test)
- External gateway for RS232, CAN and others (consult us for specific gateway)

All specifications are subject to change without notice.

1. Minimum voltage setpoint is 0V in DC. The recommended minimum setpoint for long-term use is 20Vrms in AC and 20V in DC.
2. Effective resolution measured with a 400ms window
3. FS Range of voltage is 830V (with High Voltage option)
FS Range of current is $2 \cdot |3 \cdot I_{rated}|$ (see models table)
FS Range of power is $2 \cdot |200\% \cdot P_{rated}|$ (see models table)
4. Accuracies are valid for settings above 10% of FS
5. Measured with the rated resistive load and high-dynamics controllers configuration.
6. Accuracy of measurements is $\pm 0.1\%$ of FS for rms voltage, $\pm 0.2\%$ of FS for rms current, $\pm 0.4\%$ of FS for active power (valid only above 10% of FS)
7. Consult us for lower voltage/current ripple requirements
8. Rated power figures are given at 20°C
9. The maximum output voltage depends on frequency following $V \cdot f < 230000$
10. With fast DC control behaviour

Models

GE&EL+ vAC/DC SiC

Reference	AC Power Rated ⁽⁹⁾	AC Current Rated ⁽⁹⁾ /RMS 3 channels / 1 channel	DC Power Rated ⁽⁹⁾	DC Current Rated ⁽⁹⁾ /RMS 3 channels / 1 channel	Weight (kg) (lbs)	Dimensions DxWxH (mm) (inch)
GE&EL+ 50 vAC/DC SiC + ITi	50 kW	73 A / 219 A	50 kW	±73A / ±219A	395 kg 870.82 lbs	770 x 835 x 1100 mm 30.31 x 32.87 x 43.30 "
GE&EL+ 50 vAC/DC SiC + ITe	50 kW	73 A / 219 A	50 kW	±73A / ±219A	200 kg 440.92 lbs	770 x 450 x 1100 mm 30.31 x 17.71 x 43.30 "

All specifications are subject to change without notice.

INSIDE THE CABINET	Circuit Breaker Recommended	Weight (kg) (lbs)
IT 50i*	Type C - 83 A	195 kg 429.90 lbs

*In the IT 50i models the size of the cabinet increases to a total of 770 x 835 x 1100 mm.

IN EXTERNAL CABINET IP20	Circuit Breaker Recommended	Weight (kg) (lbs)	Dimensions D x W x H (mm) (inch)
IT 50e	Type D - 125 A	280 kg 617.29 lbs	725 x 525 x 775 mm 28.54 x 20,67 x 30.51 "

Configuration Modes



Master / Slave



Channel Configuration in GE



Channel Configuration in EL



Channel Configuration in DC



Regenerative
Power Electronics
Solutions



Can Baletes 7, Nau A
08310 Argentona
Barcelona (Spain)
+34 934 864 358
cinergia@cinergiapower.com

Follow us on:
Youtube, LinkedIn, Twitter